

YS18V SERIES



Input: 100-240VAC 50/60Hz
 Output Voltage: 5V-36V DC
 Rated Power: 30W max

Features

Univeral AC input/ Full range
 Energy efficiency level VI
 Leakage Current: < 0.25mA
 Extremely low leakage current
 Protection: Over load/Over voltage/Short circuit
 Withstand voltage : 3KV
 Life Warranty: 3 years

Application

Digital equipment
 Electric curtains
 Kitchen appliances
 Household appliances



■ Dimensions and Installation

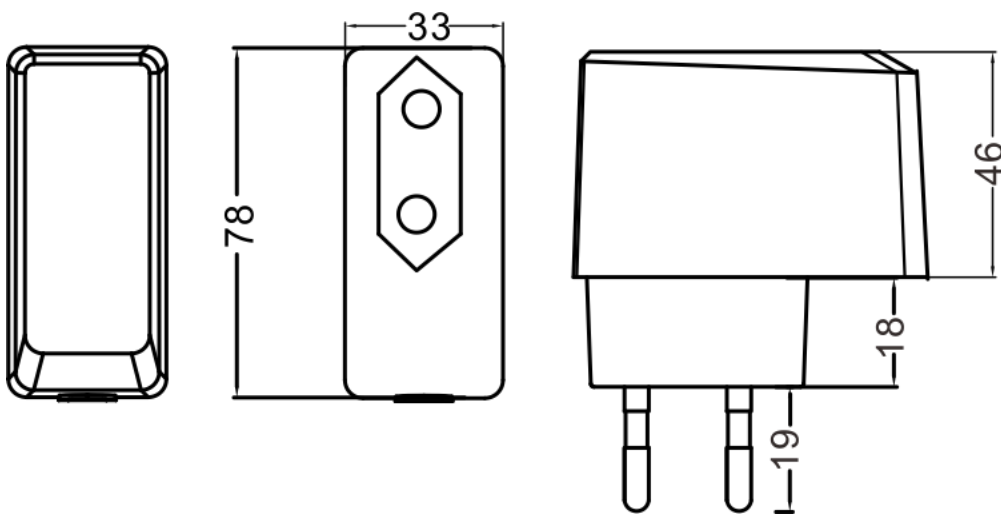

YS18V-E

YS18V SERIES

MODEL DETAIL SPEC.		YS18V-0503500	YS18V-0902500	YS18V-1202000	YS18V-1202500	YS18V-2401000	YS18V-3600600
INPUT	Input Voltage:	90-264VAC					
	Input Frequency:	50/60Hz					
	Inrush Current:	65A/230VAC					
	AC Current:	0.7A/230VAC					
	Leakage Current:	< 0.25mA/240VAC					
	Efficiency:	83%	86%	86%	87%	86.8%	87%
OUTPUT	DC Voltage:	5V	9V	12V	12V	24V	36V
	Rated Current:	3.5A	2.5A	2A	2.5A	1A	0.6A
	Rated Power:	17.5W	22.5W	24W	30W	24W	21.6W
	Voltage Tolerance:	±5.0%	±5.0%	±5.0%	±5.0%	±5.0%	±5.0%
	Ripple and Noise:	75mVp-p	90mVp-p	120mVp-p	120mVp-p	240mVp-p	300mVp-p
	Line Regulation:	±3%					
	Load Regulation:	±5%	±5%	±5%	±5%	±5%	±5%
	Setup, Rise, Hold Up time:	3000ms, 30ms/120ms 230VAC at full load					
ENVIRONMENTAL	Operating Temperature:	-20 ~ +60 (Refer to "Derating Curve")					
	Storage Temp:	-40°C ~ 85°C					
	Storage Humidity:	10 ~ 95% RH					
	Working Humidity:	20 ~ 95% RH non-condensing					
PROTECTION	Over Load:	Above 110-180% rated output power					
		Protection type: Hiccup mode, recovers automatically after fault condition is removed					
	Over Voltage:	110-140% rated output power					
		Protection type: Shut down o/p voltage, re-power on to recover					
Short Circuit :	Shut down o/p voltage, re-power on to recover						
SAFETY & EMC	Safety Regulations:	TUV, EN62368-1					
	Withstand Voltage:	I/P-O/P:3KVAC I/P-FG:2KVAC O/P-FG:0.5KVAC					
	Isolation Resistance:	I/P-O/P, I/P-FG, O/P-FG:100M Ohms / 500VDC / 25°C/ 70% RH					
	EMC Emission:	EN55032 (CISPR32), Class B, BS EN/EN61000-3-2,-3					
	EMC Immunity:	EN/EN61000-4-2,3,4,5,6,8,11					
OTHER	MTBF:	100Khrs min. MIL-HDBK-217F(25°C)					
	Size:	78*36*83mm					
	Weight:	130g / pcs					
	Packaging:	100PCS/CTN					

YS18V SERIES

Deduction curve and temperature

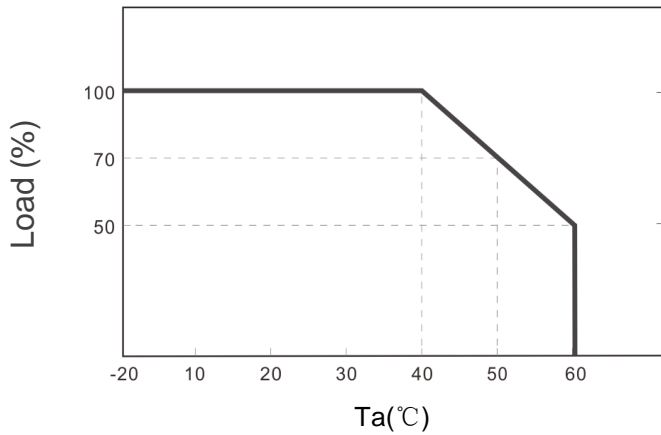

Minus output and input voltage curves

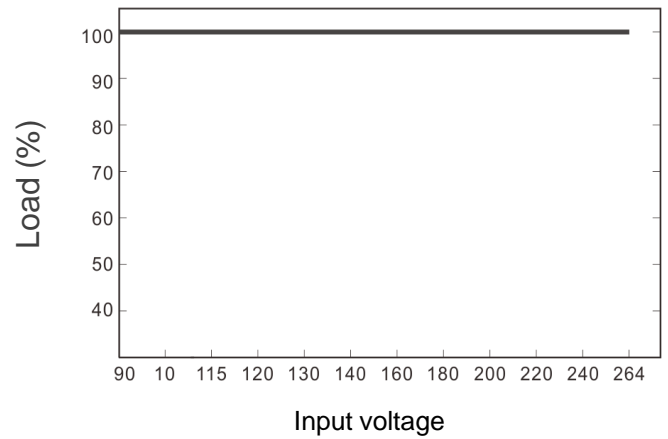

■ Functional Diagram

Standard plug: P1J

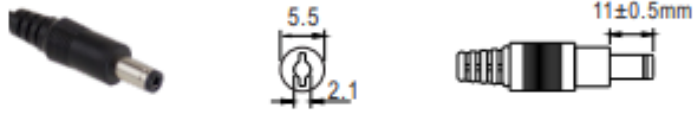
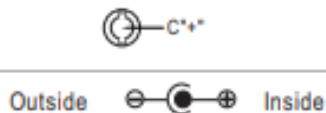
P1J	Pin Assignment
	 <p style="color: red;">-V not connected to AC FG(standard) -V connected to AC FG(optional)</p>











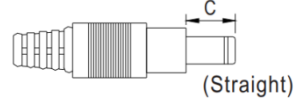
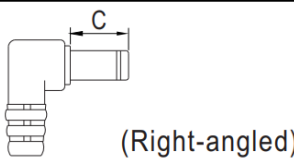

DC plug changeable through:

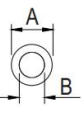
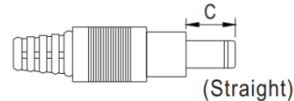
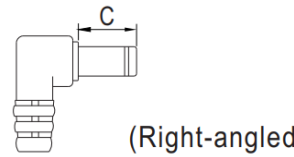
- (1) Customization of the standard part with an optional DC plug according to the table (MOQ applicable)
 - (2) Quick adapter accessory (sold separately without MOQ)
- Please refer to below table and online selection guide :

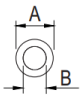
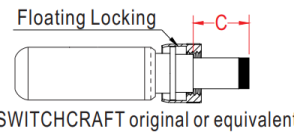
Example quick adapter accessory:

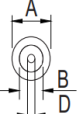
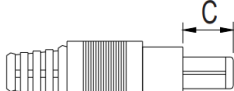





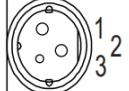
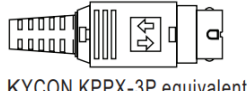

YS8V SERIES

Optional DC plug: (Available in customized cable or quick adapter)

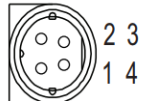
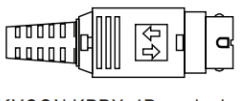
Tuning Fork Style		Type No.	A	B	C	Quick Adapter Accessory	
			OD	ID	L		
   	P1I	5.5	2.1	9.5	Available (Current rating: 7.5A max.)		
	P1L	5.5	2.5	9.5			
	P1M	5.5	2.1	11.0			
	P1IR	5.5	2.5	9.5			
	P1JR	5.5	2.1	11.0			
	P1LR	5.5	2.5	9.5			
	P1MR	5.5	2.5	11.0			
Barrel Style		Type No.	A	B	C	Quick Adapter Accessory	
			OD	ID	L		
   	P2I	5.5	2.1	9.5	None		
	P2J	5.5	2.1	11.0			
	P2L	5.5	2.5	9.5			
	P2M	5.5	2.1	11.0			
	P2IR	5.5	2.5	9.5			
	P2JR	5.5	2.1	11.0			
	P2MR	5.5	2.5	11.0			
Lock Style		Type No.	A	B	C	Quick Adapter Accessory	
			OD	ID	L		
   <p>SWITCHCRAFT original or equivalent</p>	P2S(S761K)	5.53	2.03	12.06	None		
	P2K(761K)	5.53	2.54	12.06			
	P2C(S760K)	5.53	2.03	9.52			
	P2D(760K)	5.53	2.54	9.52			
Center Pin Style		Type No.	A	B	C	D	Quick Adapter Accessory
			OD	ID	L	Center Pin	
   <p>EIAJ equivalent</p>	P4A	5.5	3.4	11.0	1.0	Available (Current rating: 7.5A max.)	
	P4B	6.5	4.4	11.0	1.4		
	P4C	7.4	5.1	11.0	0.6		
Min. Pin Style		Type No.	A	B	C	Quick Adapter Accessory	
			OD	ID	L		
   <p>EIAJ equivalent</p>	P3A	2.35	0.7	11.0	Available (Current rating: 5A max.)		
	P3B	4.0	1.7	11.0			
	P3C	4.75	1.7	11.0			

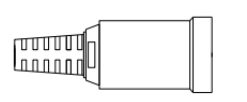
YS8V SERIES

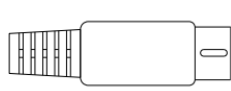
Optional DC plug: (Available in customized cable or quick adapter)

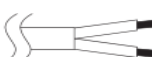
Tuning Fork Style	Type No.	Pin Assignment		Quick Adapter Accessory
		PIN No.	Output	
   <p>KYCON KPPX-3P equivalent</p>	R6B	1	+Vo	Available (Current rating: 7.5A max.)
		2	-Vo	
		3	+Vo	
Barrel Style	Type No.	Pin Assignment		Available (Current rating: 7.5A max.)
   <p>KYCON KPPX-4P equivalent</p>	R7B	PIN No.	Output	
		1	+Vo	
		2	-Vo	
		3	-Vo	
		4	+Vo	
Lock Style	Type No.	Pin Assignment		None
   <p>KYCON KPJX-CM-4S equivalent</p>	R7BF	PIN No.	Output	
		1	+Vo	
		2	-Vo	
		3	-Vo	
		4	+Vo	
Center Pin Style	Type No.	Pin Assignment		Available (Current rating: 7.5A max.)
  	R1B	PIN No.	Output	
		1	-Vo	
		2	-Vo	
		3	+Vo	
		4	-Vo	
		5	+Vo	
Center Pin Style	Type No.	Pin Assignment		None
  	by customer	1	+Vo	
		2	-Vo	