

YS39E SERIES



Input: 100-240VAC 50/60Hz
Output Voltage: 5V-36V DC
Rated Power: 40W max

Features

Univeral AC input/ Full range
Energy efficiency level VI
Leakage Current: < 0.25mA
Extremely low leakage current
Protection:Over load/Over voltage/Short circuit
Withstand voltage : 3KV
Life Warranty: 3 years

Application

Digital equipment
Electric curtains
Kitchen appliances
Household appliances



■ Dimensions and Installation

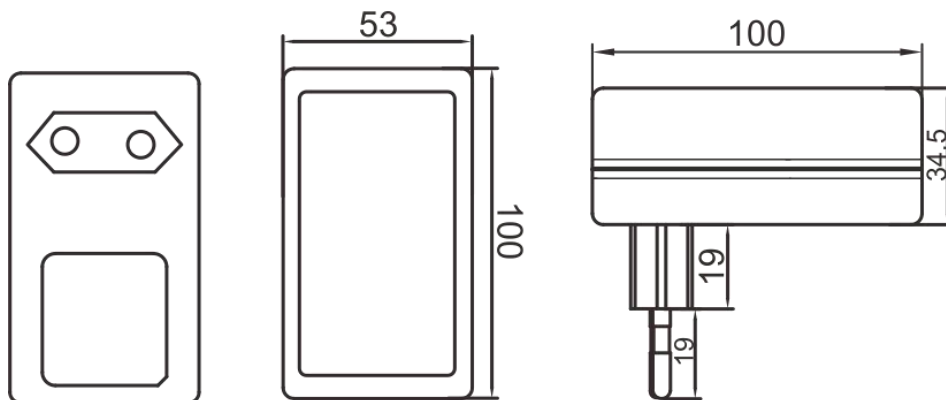

YS39E SERIES

MODEL DETAIL SPEC.		YS39-0504000	YS39-0704000	YS39-0904000	YS39-1203500	YS39-1802300	YS39-2401800	YS39-3601200
INPUT	Input Voltage:	100-240VAC						
	Input Frequency:	50/60Hz						
	Inrush Current:	65 Amps max. at 230VAC/50Hz, full load						
	AC Current:	0.8A max.						
	Leakage Current:	< 100 μ A						
	Efficiency:	83.68%	87.44%	88.3%	88.71%	88.67%	88.77%	88.77%
OUTPUT	DC Voltage:	5V	7V	9V	12V	18V	24V	36V
	Rated Current:	4A	4A	4A	3.5A	2.3A	1.8A	1.2A
	Rated Power:	20W	28W	36W	42W	41.4W	43.2W	43.2W
	Voltage Tolerance:	\pm 5.0%	\pm 5.0%	\pm 5.0%	\pm 5.0%	\pm 5.0%	\pm 5.0%	\pm 5.0%
	Ripple and Noise:	100mVp-p	100mVp-p	100mVp-p	120mVp-p	180mVp-p	240mVp-p	360mVp-p
	Line Regulation:	\pm 3%						
	Load Regulation:	\pm 5%	\pm 5%	\pm 5%	\pm 5%	\pm 5%	\pm 5%	\pm 5%
	Setup, Rise, Hold Up time:	500ms, 30ms/120ms 230VAC 1000ms, 30ms/25ms 115VAC at full load						
ENVIRONMENTAL	Operating Temperature:	-20 ~ +60 (Refer to "Derating Curve")						
	Storage Temp:	-40 $^{\circ}$ C ~ 85 $^{\circ}$ C						
	Storage Humidity:	10 ~ 95% RH						
	Working Humidity:	20 ~ 95% RH non-condensing						
PROTECTION	Over Load:	Above 105% rated output power Protection type: Hiccup mode, recovers automatically after fault condition is removed						
	Over Voltage:	5V:5.75~6.75V 6V:6.7~8.1V 9V:10.35~12.15V 12V:13.8~16.2V 18V:20.7~24.3V 24V:27.6~32.4V 36V:41.4~48.6V Protection type: Shut down o/p voltage, re-power on to recover						
	Over Temperature:	Shut down o/p voltage, re-power on to recover						
SAFETY & EMC	Safety Regulations:	UL508, TUV BS EN/EN62368-1, EAC TP TC 004, BSMI CNS14336-1, AS/NZS 62368.1 approved						
	Withstand Voltage:	I/P-O/P:3KVAC I/P-FG:2KVAC O/P-FG:0.5KVAC						
	Isolation Resistance:	I/P-O/P, I/P-FG, O/P-FG:100M Ohms / 500VDC / 25 $^{\circ}$ C/ 70% RH						
	EMC Emission:	Compliance to BS EN/EN55032 (CISPR32), BS EN/EN61204-3 Class B, BS EN/EN61000-3-2,-3, EAC TP TC 020, CNS13438 Class B						
OTHER	Size:	100*53*34.5mm						
	Weight:	160g / pcs						
	Packaging:	100PCS/CTN						

YS39E SERIES

Deduction curve and temperature

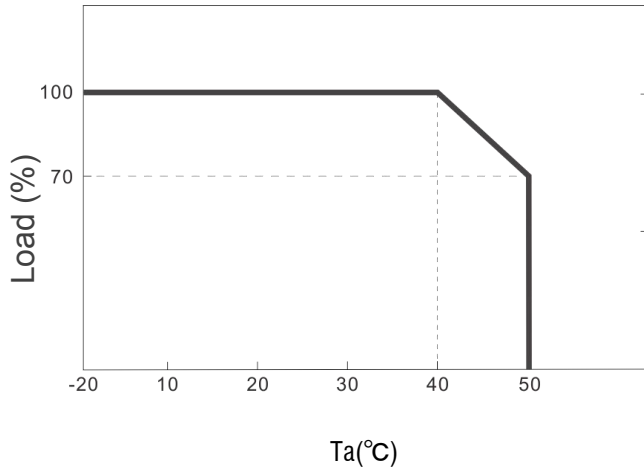

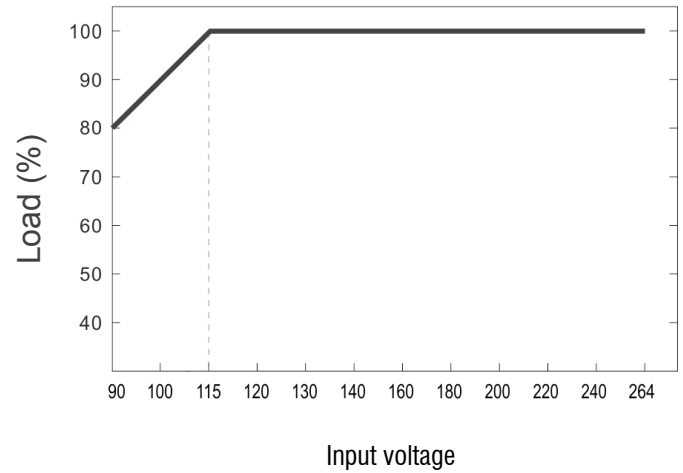

Minus output and input voltage curves

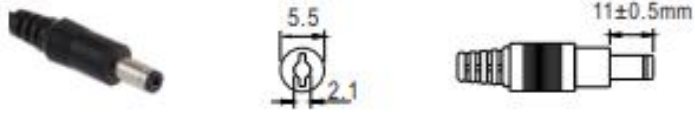
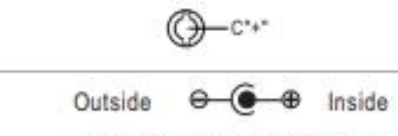

■ Functional Diagram

Standard plug: P1J

P1J	Pin Assignment
	
	<p>Outside  Inside</p> <p>-V not connected to AC FG(standard)</p> <p>-V connected to AC FG(optional)</p>

DC plug changeable through:









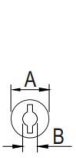
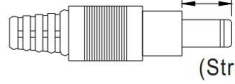
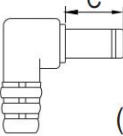

- (1) Customization of the standard part with an optional DC plug according to the table (MOQ applicable)
- (2) Quick adapter accessory (sold separately without MOQ)

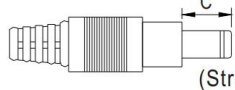
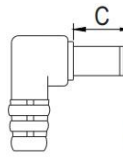
Please refer to below table and online selection guide :

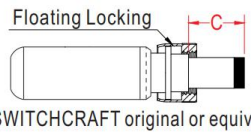
Example quick adapter accessory:

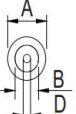
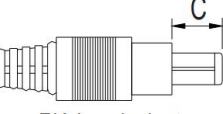





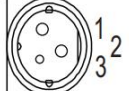
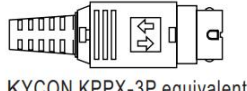

YS39E SERIES

Optional DC plug: (Available in customized cable or quick adapter)

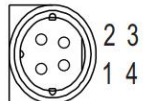
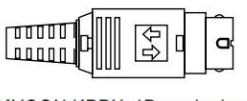
Tuning Fork Style		Type No.	A	B	C	Quick Adapter Accessory	
			OD	ID	L		
   (Straight)	P1I	5.5	2.1	9.5	Available (Current rating: 7.5A max.)		
	P1L	5.5	2.5	9.5			
	P1M	5.5	2.1	11.0			
	 (Right-angled)	P1IR	5.5	2.5		9.5	
		P1JR	5.5	2.1		11.0	
		P1LR	5.5	2.5		9.5	
		P1MR	5.5	2.5		11.0	
Barrel Style		Type No.	A	B	C	Quick Adapter Accessory	
			OD	ID	L		
   (Straight)	P2I	5.5	2.1	9.5	None		
	P2J	5.5	2.1	11.0			
	P2L	5.5	2.5	9.5			
	P2M	5.5	2.1	11.0			
	 (Right-angled)	P2IR	5.5	2.5		9.5	
		P2JR	5.5	2.1		11.0	
		P2LR	5.5	2.5		9.5	
P2MR		5.5	2.5	11.0			
Lock Style		Type No.	A	B	C	Quick Adapter Accessory	
			OD	ID	L		
   Floating Locking SWITCHCRAFT original or equivalent	P2S(S761K)	5.53	2.03	12.06	None		
	P2K(761K)	5.53	2.54	12.06			
	P2C(S760K)	5.53	2.03	9.52			
	P2D(760K)	5.53	2.54	9.52			
Center Pin Style		Type No.	A	B	C	D	Quick Adapter Accessory
			OD	ID	L	Center Pin	
   EIAJ equivalent	P4A	5.5	3.4	11.0	1.0	Available (Current rating: 7.5A max.)	
	P4B	6.5	4.4	11.0	1.4		
	P4C	7.4	5.1	11.0	0.6		
Min. Pin Style		Type No.	A	B	C	Quick Adapter Accessory	
			OD	ID	L		
   EIAJ equivalent	P3A	2.35	0.7	11.0	Available (Current rating: 5A max.)		
	P3B	4.0	1.7	11.0			
	P3C	4.75	1.7	11.0			

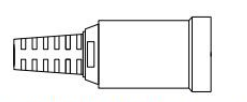
YS39E SERIES

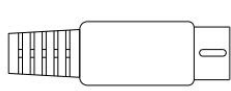
Optional DC plug: (Available in customized cable or quick adapter)

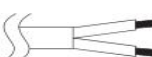
Tuning Fork Style	Type No.	Pin Assignment		Quick Adapter Accessory
		PIN No.	Output	
   <p>KYCON KPPX-3P equivalent</p>	R6B	1	+Vo	Available (Current rating: 7.5A max.)
		2	-Vo	
		3	+Vo	
Barrel Style	Type No.	Pin Assignment		Available (Current rating: 7.5A max.)
   <p>KYCON KPPX-4P equivalent</p>	R7B	PIN No.	Output	
		1	+Vo	
		2	-Vo	
		3	-Vo	
		4	+Vo	
Lock Style	Type No.	Pin Assignment		None
   <p>KYCON KPJX-CM-4S equivalent</p>	R7BF	PIN No.	Output	
		1	+Vo	
		2	-Vo	
		3	-Vo	
		4	+Vo	
Center Pin Style	Type No.	Pin Assignment		Available (Current rating: 7.5A max.)
  	R1B	PIN No.	Output	
		1	-Vo	
		2	-Vo	
		3	+Vo	
		4	-Vo	
		5	+Vo	
Center Pin Style	Type No.	Pin Assignment		None
  	by customer	PIN No.	Output	
		1	+Vo	
		2	-Vo	