

SBP2WEB24

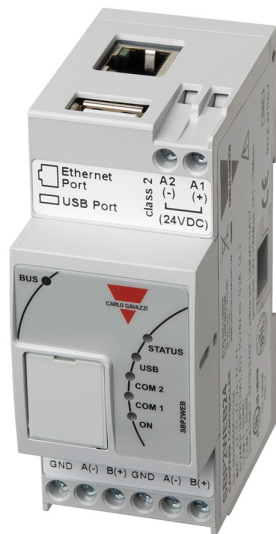

Dupline® Carpark Controller



Benefits

- Compact and flexible Carpark Controller
- Parking guidance, booking, carpark management and smart building controls in one system
- Energy savings through active occupancy management and lighting/ventilation control
- Can manage up to 7 Dupline® 3-wire networks, each with up to 90 carpark sensors
- Possibility to link up 10 controllers together with SBP2CPY24 carpark server
- Seamless integration with BMS through BACnet/IP
- Built-in webserver with user interface for carpark management software
- User-friendly PC-based configuration tool

Description

The SBP2WEB24 Carpark Controller is part of the Dupline® Carpark system.

In addition to the Carpark sensors, indicators and display interfaces, it is also possible to connect other sensors and I/O-modules like PIR detectors, lux sensors, light switches, relay modules and DALI dimmers, thereby allowing energy saving functions for lighting and ventilation to be implemented in the same controller and network that manages the Carpark system.

The various I/O's and function parameters are available as BACnet/IP objects through the Ethernet port, thereby allowing seamless integration with any building management system. The SBP2WEB24 also features a Carpark management software implemented as webserver, with graphical user interface for monitoring and booking, alarm handling and statistics functions, all available through a standard browser.

Applications

Parking Guidance Systems

Main functions

- Management of Dupline® networks with sensors and displays and control functions for carpark guidance, as well as

functions for energy-saving lighting control and ventilation in the carpark.

▶ Main hardware characteristics

Communication ports	
RS485	1 port
Ethernet	1 port, for LAN connection
Auxiliary bus	
Right side	Compatible with Carpark SBP2MCG324



Features

Power Supply

Rated operational voltage	15- 24 VDC ($\pm 20\%$), 0.2 A, CL.2
Rated impulse voltage	500 V (1.2/50 μ s) (IEC 60664-1, tab. F.1)
Rated operational power	5 W
Reverse-polarity protection	Yes
Connection	A1 (+) and A2 (-)
Power-OFF delay	1 s

Input/output isolation

Type of input/output	DC Power supply	RS485 - COM 1	RS485 - COM 2	Ethernet	USB port "H" (host)	USB port "D" (service)	SH2UM-MF124
DC Power supply	-	2 kV	2kV	0.5 kV	0 kV	0 kV	0 kV
RS485 - COM 1	2 kV	-	0.5 kV		2 kV	2 kV	2 kV
RS485 - COM 2 (energy meter)	2 kV	0.5 kV	-	2 kV	2 kV	2 kV	2 kV
Ethernet (LAN/Internet)	0.5 kV	2 kV	2 kV	-	0.5 kV	0.5 kV	0.5 kV
USB port "H" (host)	0 kV	2 kV	2 kV	0.5 kV	-	0 kV	0 kV
USB port "D" (service)	0 kV	2 kV	2 kV	0.5 kV	0 kV	-	0 kV
SH2UM-MF124	0 kV	2 kV	2 kV	0.5 kV	0 kV	0 kV	-

- 0 kV: inputs/outputs are not insulated
- 0.5 kV rms: the insulation is functional type
- 2 kV rms: EN61010-1, IEC60664-1 - over-voltage category III, pollution degree 2, double insulation on systems with max. 300Vrms to ground

LEDs indication

Green LED	Power status	ON: power ON OFF: power OFF Flashing: 200ms ON 200ms OFF writing in progress on the μ SD memory, do not remove it.
Yellow LED	COM 1	OFF: no communications on RS485 A. Flashing: 200ms ON 600ms OFF, no answer from the slave. Flashing: 200ms ON 200ms OFF, communications OK.
	COM 2	OFF: no communications on RS485 B. Flashing: 200ms ON 600ms OFF, no answer from the slave. Flashing: 200ms ON 200ms OFF, communications OK.
	BUS	OFF: no communication is present on the HSbus. ON: communication error on HSbus. Flashing: communication OK on HSbus.
Blue LED	USB	ON: acknowledged device, no writing in progress, device can be removed. OFF: neither acknowledged device nor connected device. Flashing: acknowledged device and writing cycle in progress, device cannot be removed.
Red LED	Status	ON: NO configuration present. OFF: configuration present in the SBP2WEB24. Flashing: SBP2WEB24 is connected to the configuration tool.

Environmental

Ambient temperature	-25°... +50°C (-4°... +122°F) (R.H. < 90% non-condensing @ 40°C)	Operating
	-30° ... +70°C (-22° ... +158°F) (R.H. < 90% non-condensing @ 40°C)	Storage
Dielectric strength	4000 VAC rms	for 1 min.
Noise rejection (CMRR)	>65dB	45 to 65 Hz
Overvoltage category	III	IEC60664; EN60947-1. For inputs from string: equivalent to Cat. I, reinforced insulation.
Standard compliance safety	IEC60664, IEC61010-1, EN60664, EN61010-1	

EMC

Immunity According to EN61000-6-2	
Electrostatic discharges	IEC 61000-4-2
Radiated radiofrequency	EN61000-4-3
Burst immunity	EN61000-4-4
Surge	EN61000-4-5
Conducted radio frequency	EN 61000-4-6
Power frequency magnetic fields	EN 61000-4-8
Voltage dips, variations, interruptions	EN 61000-4-11
Emission According to EN61000-6-3	
Conducted and radiated emissions	CISPR 22 (EN55022), cl. B
Conducted emissions	CISPR 16-2-1 (EN55016-2-1)
Radiated emissions	CISPR 16-2-3 (EN55016-2-3)

HS Bus specifications

Bus type	RS485 high speed bus
Function	Connection to Carpark master generator (SBP2MCG324)
Number of slaves	Max 7
Connection	By local bus on the right side. Note: All the SBP2MCG324 modules have to be connected on the right side of the SBP2WEB24.



Ports

RS485

Number of ports	1
Connections	Multidrop, bidirectional (static and dynamic variables)
Addresses	247
Protocol	MODBUS
Data (Bidirectional)	All data
Data format	Selectable: 1 start bit, 7/8 data bit, no/odd/even/ parity, 1/2 stop bit
Baud-rate	Selectable: 9600, 19200, 38400, 115200, bits/s
Driver input capability	1/8 unit load. Up to 256 nodes on a network.
Insulation	See the table "Insulation between inputs and outputs"

Ethernet

Protocol	HTTP
IP configuration	Static IP / Netmask / Default gateway
DNS	Primary and secondary DNS as a static or dynamic management (using DHCP server if configured)
Connections	RJ45 10/100 BaseTX, Max. distance: 100m
Insulation	See "Input/output insulation" table

Mechanics

Housing

Dimensions (HxWxD)	35 x 90 x 67 mm	
Housing material	Noryl, self-extinguishing V-0 (UL94)	
Mounting	DIN rail	
Degree of protection	Front	IP40
	Screw terminal	IP20
Weight	Approx. 150 g	Packing included

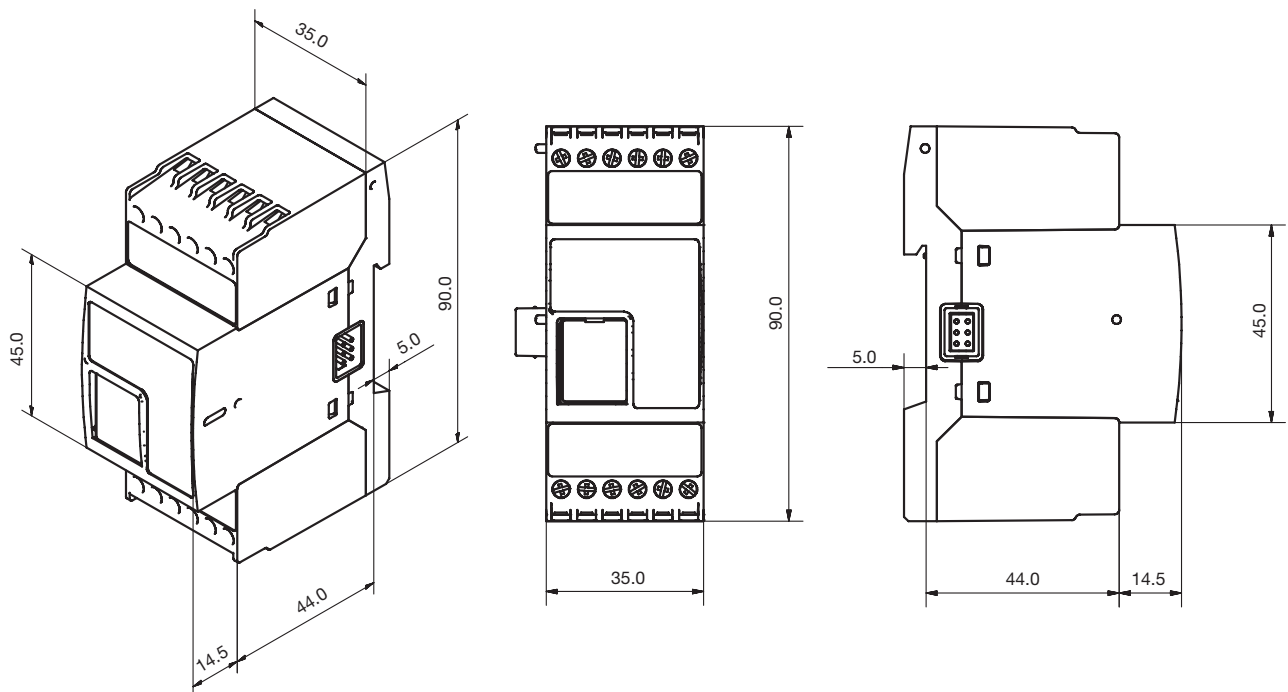

Connection

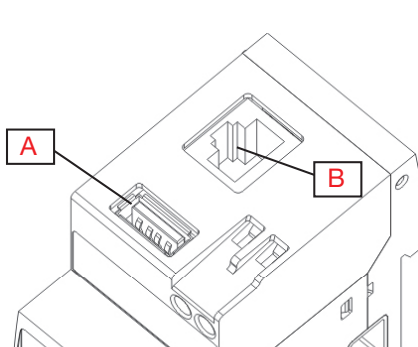

Fig. 1 USB host and LAN port

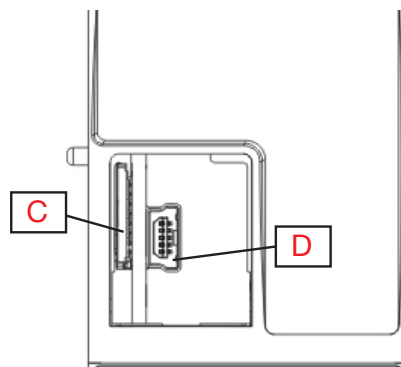

Fig. 2 Micro SD slot and mini USB

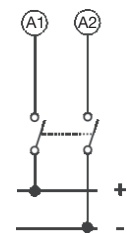

Fig. 3 Power supply

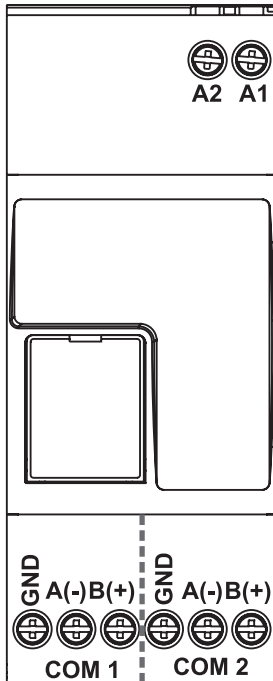

Fig. 4 Frontal connectors

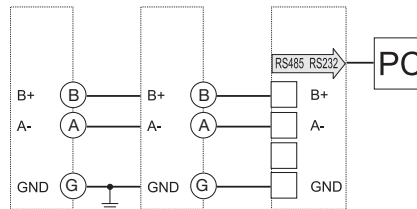

Fig. 5 RS485 port COM1

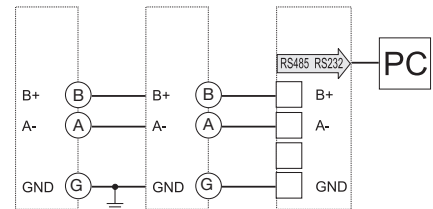

Fig. 6 RS485 port COM2

A	USB host	C	Micro SD slot
B	LAN port	D	Mini USB

Connections

Ethernet	RJ-45 connector	10/100Base-T
RS485	3 screw terminals per port	
	Cable cross-section area	1.5 mm ² Max.
	Screws tightening torque	min. 0.4 Nm, Max. 0.8 Nm
Power supply	2 screw terminals	
	Cable cross-section area	1.5 mm ² Max.
	Screws tightening torque	min. 0.4 Nm, Max. 0.8 Nm

Mode of operation

The SBP2WEB24 Carpark controller needs to be configured to become operational.

When the SBP2WEB24 is connected to the TCP/IP network, the user can scan the system via the PC-based configuration tool to discover all Carpark sensors, LED indicators, displays etc. connected.

It is also possible to enter the modules manually in offline mode. Each Dupline® module has a so-called SIN address (printed on the packaging and on the module) which must be noted down in order to uniquely identify each module.

For the Carpark sensor, however, a faster method can be used. The SIN-addresses are simply read into the controller by bringing it into address read mode and then pressing the button in the bottom of each sensor one by one in a line.

Subsequently, the tool will automatically configure the connected Dupline® modules over the bus.

Once all modules with data points have been defined, it is possible to define the functions that use them.

Some of the functions are predefined with inputs, outputs and operational parameters, while others are standard types, such as logic, timers, real-time, sequence, data logging etc.

In order to ease testing and troubleshooting during commissioning, the configuration tool also provides the option to monitor live data from the SBP2WEB24.

All physical data points in the system and several function parameters are automatically made available as BACnet/IP objects, thereby providing an option for seamless integration with the building management system.

The SBP2WEB24 can also host the Carpark server software that controls the sensors, displays and indicators of the parking guidance system, manages alarms and bookings, and provides a graphical user interface via webserver.

Further information regarding programming can be found in the configuration manual.



This manual can be found on <http://productselection.net/searchproduct.php>

Further information regarding installation of CPIII can be found in the Installation manual.

This manual can be found on <http://productselection.net/searchproduct.php>

Compatibility and conformity

Approvals and markings

BTL certified	
CE-marking	
Approvals	

UL notes

- This product is intended to be supplied by a Listed Information Technology Equipment AC Adaptor marked NEC Class 2 or LPS
- Max ambient temperature: 50°C (122°F)



References

 Product selection key

 SBP2WEB24



COPYRIGHT ©2016
Content subject to change. Download the PDF: www.productselection.net